

Neptune EMX 075 PI MS Electronic Parallel Mixing System Eng. No. 943708

Pressure Drop PSI		5	10	20	30
Valve	Inlet Size	CAPACITY GPM AS BUILT			
NEPTUNE EMX 075	1-1/4"	34	49	68	86

Minimum flowrate: 1/4 gpm when properly installed at or near the hot water source recirculating tempered water with a properly sized continuously operating recirculation pump. (5 gpm min per valve)

- 1-1/4" inlets and outlet
- Stainless Steel Construction
- ASSE 1017 and NSF 372 (lead free) listed
- Maximum operating pressure: 150 psi
- Controls water temperature to +/- 2°F when properly installed in a continuous recirculation system
- Low Load algorithm keeps temperature steady in low demand periods
- Fails "last position" during power failure
- Automatic Hot/Cold water shutoff upon cold/hot water inlet supply failure
- Recommended recirculation pipe size: 1" or greater
- System includes recirculation pump, circuit setting balancing valve, thermometers, ball valves, check valves, mounting strut and test connection
- Programmable high temperature alarm function
- Programmable set point range between 95°F to 180°F (Default set temperature 120°F)
- Control box supplied with 4 ft. 120 VAC power cord and NEMA 4 enclosure
- Modbus communication standard
- Easy integration into BMS system
- Operating Voltage: 24 VDC
- Simple user commissioning and setup
- Displays outlet temperature
- Removeable and serviceable thermocouple probe
- Factory Assembled and Tested
- Minimum hot water supply temperature: 2°F (1°C) above set point with equal incoming pressures

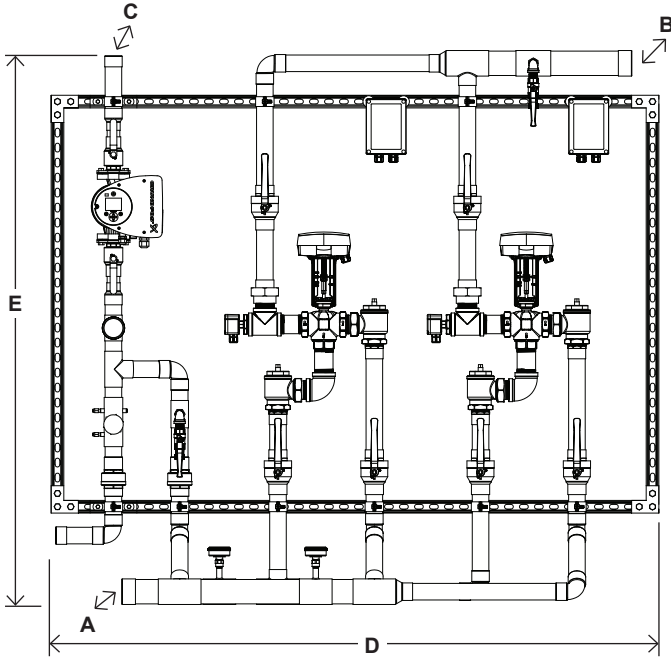

DIMENSIONS

Valve Number	A N.P.T.	B N.P.T.	C N.P.T.	D	E
EMX 075	1-1/4"	1-1/4"	1"	72"	66"

Dimensions are for reference purposes only. For rough-in dimensions please refer to Lawler's Revit/BIM models found at temperedwater.com.

Neptune EMX 075 PI MS Electronic Parallel Mixing System Eng. No. 943708

Typical Installation

Install the mixing valve below the hot water tank or heater. If this is not possible, pipe in a heat trap as shown in Figure 1 with an approximate 2' drop.

Connect a tempered water return line as shown in Figure 1. This allows flow through both ports of the mixing valve during periods of no draw.

If a dual temperature system is used, a separate recirculating loop and pump are required to return high temperature hot water to the water heater. See Figure 2.

Install the water heater per manufacturer's instructions.

Figure 1

When used in a single temperature recirculating system

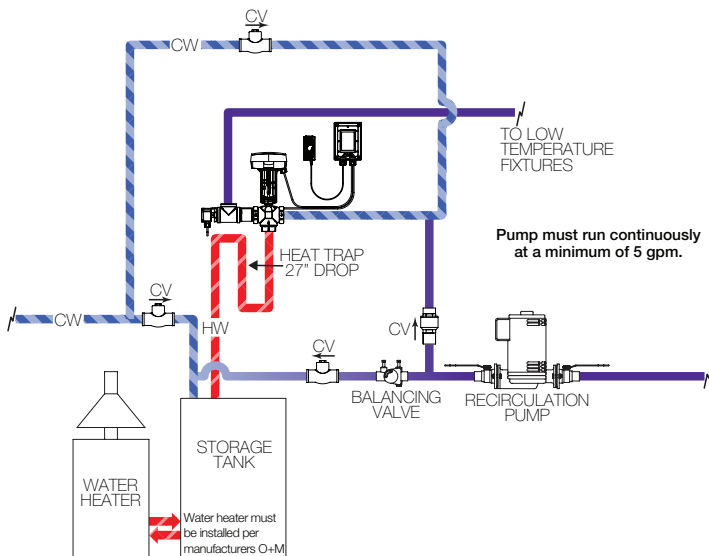

Figure 2

When used in a dual temperature recirculating system

